

Dimensions: TRANSPORT DOLLIES

Model A30

Top View

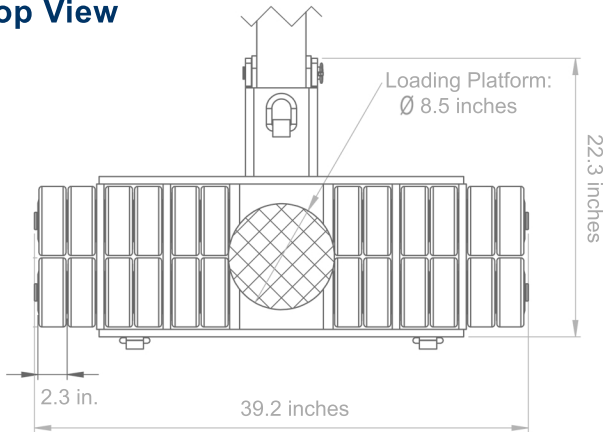

Side Views

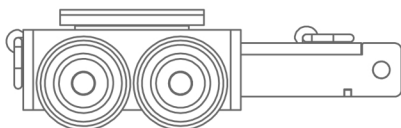
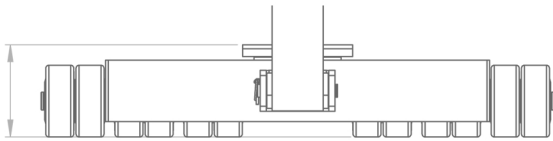

Pulling handle

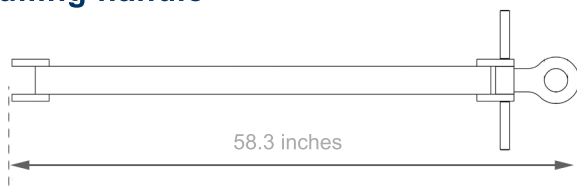

Model B30

Top View

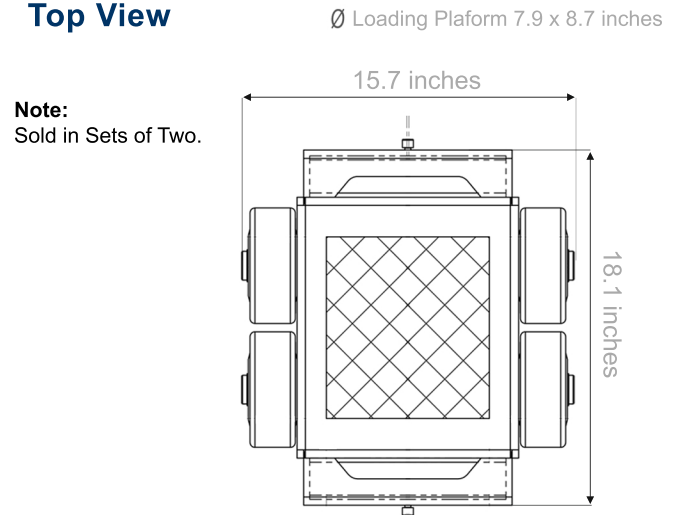

Side Views

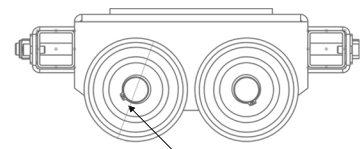
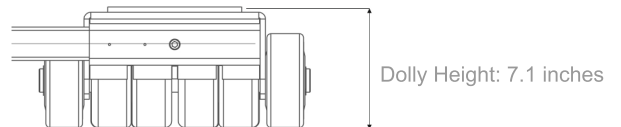

Connecting bar

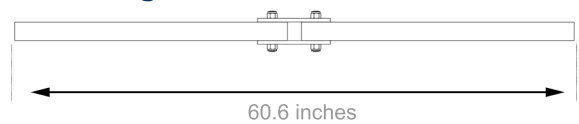

For larger loads, dollies can be used without a connecting bar or users can build their own. Contact your sales representative for additional information.