

## Dimensions: TANDEM MACHINE SKATES

### Model T30

Top View

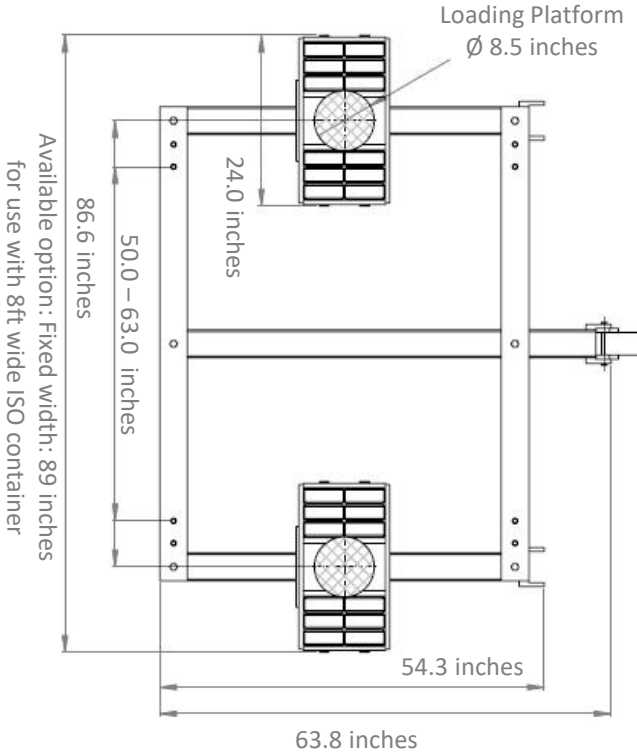

Side Views

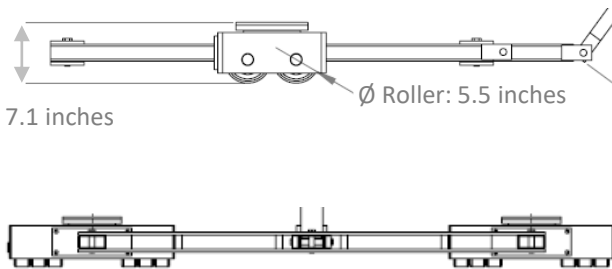

Pulling Handle



### Model B30

Top View

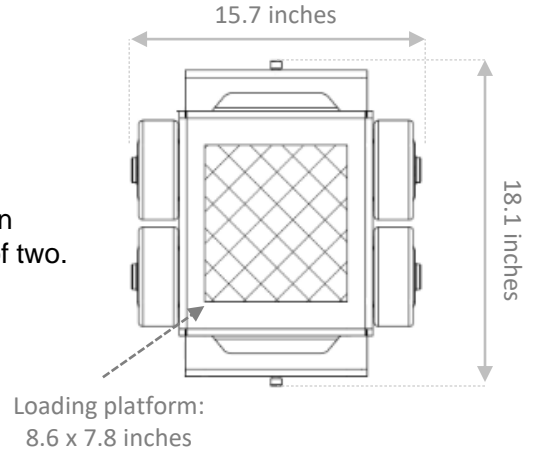

Side Views

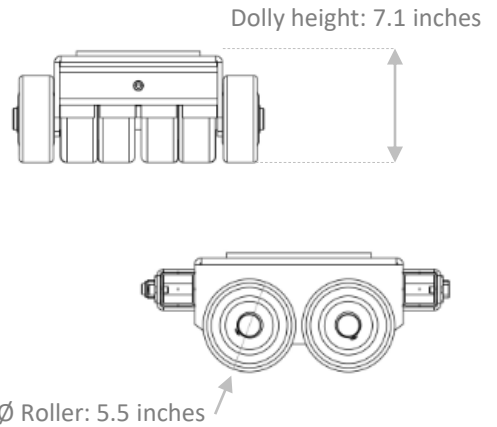

Connecting Bar

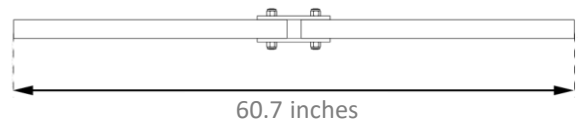

Extended connecting bar: 89 inches  
also available for 8ft wide ISO container use.